



**Hydraulic Disc Brake, Installation,
Maintenance, and Service Manual**

**HFX-Mag
HFX-Mag Plus
HFX-9
HFX-9 HD**

Introduction to this Manual

This manual is intended to provide the information necessary for normal maintenance and service of the Hayes Disc Brake system. Although the steps and procedures are relatively simple, they should not be attempted until you are thoroughly familiar with the entire set of procedures. Photographs of actual hardware have been provided to help you in the steps and procedures.

Cautions, Warnings, Notes, etc

Within this manual are specifically labeled comments intended to bring special attention to a general procedure or detailed steps. Be aware of, and understand, the meaning of these labels.

Warning: Means that there is the possibility of personal injury to yourself or to others.

Caution: Means that there is the possibility of damaging the brake or the bike.

Note: Provides general information.

Hint: Provides information that can help you properly complete a specific procedure.

Glossary

To help you become familiar with some of the terms associated with disc brakes, and in particular the Hayes Disc Brake, we provide the following glossary.

Burnish: The breaking in period of a disc brake system until the brake achieves full power.

Bleed: Removing the air from a full hydraulic system.

Bladder: The part on the Hayes Disc Brake system that contains the fluid reservoir. The bladder expands as the fluid heats up and expands, and contracts as the caliper pistons move out as the brake pads wear.

Full Hydraulic: A Hydraulic system where pressure is generated directly through activation of the lever.

Master Cylinder: The part on the Hayes Disc Brake system that generates pressure in the full hydraulic system. The master cylinder is activated through the lever.

Caliper: The part of the Hayes Disc Brake system that holds the brake pads, and clamps on the disc to slow the wheel.

Recommended Fluids and Lubricants

Use only DOT 3 or DOT 4 brake fluid. Do not use any petroleum-based lubricants, as this will cause the rubber parts to swell. Hayes recommends the use of DOT 4 or DOT 3 brake fluid. Clean the disc and pads only with isopropyl alcohol.

Personal Preference Adjustments

In most cases, the Hayes Disc Brake system has been pre-assembled for your bike. However there are a couple of adjustments that you can make to match your particular physical characteristics or personal preferences.

Positioning the Master Cylinder and Lever

1. Loosen, but do not remove, the handlebar clamp screw.
2. Then, position the Master Cylinder and Lever on the handlebar in your desired position.
3. Torque the handlebar clamp screw to:

HFX Mag or Mag Plus:	15-20 in-lbs (1.69 - 2.25 Nm).
HFX 9:	30-35 in-lbs (3.38 - 3.94 Nm).

Lever Reach Adjustment

1. Adjust the brake lever reach by using a 2.0 mm Allen wrench and turning the push rod that goes through the lever adjusting bushing. Do not attempt to force the adjustment screw beyond its limits.

Burnish

Disc brakes require a special burnish period to achieve maximum braking power. This burnishing period lasts for about 30-40 stops. During this period some noise may occur.

Safety Info

This brake has been designed for use on a single person mountain bike. The use on any other vehicle or device will void the warranty and can cause serious injury.

For riders using the brakes in downhill conditions, it is recommended that you use the 8" version of the Hayes brake. This includes the HFX-Mag or HFX-9 HD Hayes brakes with 8" discs. Not all frames and forks will accept an 8" disc. Please check with your frame and fork manufacturer or www.hayesdiscbrake.com for 8" disc compatibility. Consistently using the 6" disc in downhill conditions may cause the brake fluid to boil.

As a serious rider you are probably well aware of the need to practice safety in all aspects of the sport. This includes service and maintenance practices as well as riding practices. Before each ride, always check your brakes for proper function and the brake pads for wear. When you ride, always wear a helmet.

Installation

The following procedures cover the installation of Hayes Disc Brakes purchased as an aftermarket item. If you have purchased a bike new - with Hayes Disc Brakes already installed - you will not immediately require all of the procedures. When you need to install any of the disc brake components, a qualified technician with the proper tools should do that installation work. Improper installation could cause severe or fatal injuries.

A. Tools Required

- Torx T25 driver
- Open-end wrenches; 6mm, 8mm, 10mm
- Scissors or cable cutters
- Small Phillips screwdriver
- Torque wrench
- Small flathead screwdriver
- Allen drivers: 2.0mm and 5mm

B. Mounting the Disc to the Hub

Note: Mounting the brake disc to the wheel is a simple matter, but one that requires care. If the wheel has to be rebuilt, have it done by a qualified technician using a 3 cross spoke pattern. We recommend the use of steel, quick release skewers only.

1. Clean the disc and the hub-mounting surface with isopropyl alcohol (not disc brake cleaners).
2. Place the disc on the hub-mounting surface. Be sure that the arrow on the disc is pointing in the same direction of the forward wheel rotation.
3. Using a Torx T25 driver, install, tighten, and torque the disc screws to 55 in-lbs (6.2 Nm), in a star pattern sequence.
4. Check and re-torque the disc screws after 12 hours

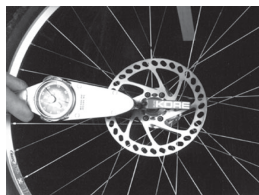

Tightening the Disc Screws

Warning: Do not touch the disc immediately after use - it will be hot.

C. Mounting the Caliper to the Frame or Fork

1. Remove the wheel(s).
2. For some installations it will be necessary to mount an adapter to accept the Hayes Disc Brake caliper. Mount the fork adapter to the fork using (2) M6 x 1.0 18.4mm long mount bolts.
Torque the bolts to 110 in-lbs (12.43Nm).
3. Mount the caliper to the frame or fork adapter using (2) M6 x 1.0 18.4mm long mount bolts and (2) mount washers. Snug the bolts, but leave them loose enough so that the caliper will move on its slots.

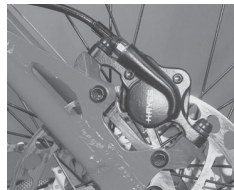

4. Re-install the front wheel.
5. Squeeze and hold the brake lever. While holding the brake lever, shake the caliper to position it in its natural centered position over the disc. While still squeezing the lever, tighten the mounting bolts.

Warning: Do not adjust the caliper while the caliper is hot

Warning: Do not adjust the caliper while the wheel is spinning.

6. Release the lever, spin the wheel. Check that it spins freely and that the gaps, between the pad and the disc, are equal. If the gaps are unequal, or there is drag, readjust the caliper position by loosening the mounting bolts and adjusting the caliper as needed.

Hint: A white piece of paper can be used as a background to help sight down the disc looking for equal clearance between the pads and the disc.

7. When the gaps are equal and wheel spins freely (without drag), torque the mounting bolts to 110 in-lbs (12.43 Nm).
8. Repeat the procedure for the other wheel.



C. Hose Removal and Assembly

The hose assembly procedure is different for the different brake models and design variations. Pay close attention to which procedure applies for your Hayes disc brake system.

Hose Removal

HFX-9, HFX-9 HD, HFX-Mag, and HFX-Mag Plus Master Cylinder and G1 (Generation 1) Caliper Hose Removal

To take the hose off of the master cylinder end, slide the hose support down the hose. Remove the hose nut by loosening the nut and sliding it all the way down the hose.

1. Slide the hose off the end of the master cylinder. There will be some residual fluid in the hose and master cylinder. Be careful to avoid spilling that fluid.

Caution: For the HFX-Mag and HFX-Mag Plus, pull the hose off straight off. Not doing so may result in a broken cartridge tip.

2. A new compression bushing will be needed each time the hose is re-installed. Remove the old compression bushing by cutting the hose next to the compression bushing. The cut needs to clean with no fraying ends.

Note: Check the hose length for adequate travel. If too short, replace hose.

G2 Caliper Hose Removal (Generation 2)

1. To take the hose off the caliper end, loosen the hose connection with a 10mm open-end wrench.
2. Remove the hose connection completely from the caliper. Be sure that the hose connection seal is not lost.

Note: The end of the G2 caliper hose is a permanent crimp. Therefore the connection cannot be trimmed to size or repaired. Shortening of the hose must be done at the master cylinder end. If the caliper hose connection is damaged, the hose must be completely replaced with a new hose with a permanent crimp attached.

Hose Assembly

G2 Caliper Hose Assembly (Generation 2)

1. Locate end of hose with the permanent crimp attached.
2. Place the hose connection seal over the threaded end. Make sure the seal is not twisted.
3. Install hose connection to the G2 caliper.
4. Using a 10mm open-end wrench, torque the hose connection to 60 +/- 5 in/lb.



G2 Caliper Hose Assembly

G1 Caliper Hose Assembly (Generation 1)

1. Locate the end of hose with permanent crimp attached.
2. Cut the permanent crimp off of the hose. This permanent crimp is not needed with the Generation 1 (G1) caliper. The end must be clean and perpendicular to the hose itself.
3. Slide the G1 caliper hose nut and compression bushing over the hose. Always use a new compression bushing.
Note: *The G1 caliper hose nut has internal threads and the compression bushing is a silver color.*
4. Slide the hose over the barbed end on the caliper banjo and install the hose nut.
5. Using a 10mm open-end wrench, torque the hose nut to 40 in-lb plus one full rotation.

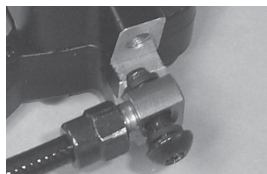

G1 Caliper Hose Assembly

HFX – 9, HFX-9 HD Master Cylinder Hose Assembly

1. Locate the end of hose without the permanent crimp attached.
2. Cut the hose to the desired length with good scissors or cable cutters. The cut end must be clean and perpendicular to the hose itself.
3. Slide the HFX-9 nose cone onto the hose.
Note: *The HFX-9 nose cone is the smaller of the two included.*
4. Slide the HFX-9 hose nut and compression bushing over the hose. Always use a new compression bushing.
Note: *The HFX-9 hose nut has external threads and the compression bushing is a gold color.*
5. Push the longer end of the HFX-9 barbed hose insert into end of hose. Be sure it is inserted flush with the end of hose. Always use a new hose insert.
6. Place the hose inset o-ring over the exposed end of the hose insert.
7. Slide hose, with hose inset and o-ring, into the HFX-9 master cylinder and install the hose nut. Be sure that the hose is inserted completely into the master cylinder end. Be sure the hose remains inserted while tightening.
8. Using a 8mm open-end wrench, torque the hose nut to 60 +/- 5 in/lb.
9. Bleed the system.

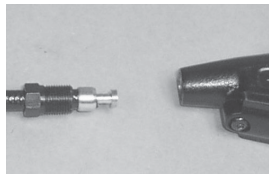

HFX-9 Hose Assembly

HFX-Mag/HFX -Mag Plus Master Cylinder Hose Assembly

1. Locate the end of hose without the permanent crimp attached.
2. Cut the hose to the desired length with good scissors or cable cutters. The cut end must be clean and perpendicular to the hose itself.
3. Slide HFX-Mag nose cone onto the hose.
Note: *The HFX-Mag nose cone is the larger of the two.*
4. Slide the HFX-Mag hose nut and compression bushing over the hose. Always use a new compression bushing.
Note: *The HFX-Mag hose nut has internal threads and the compression bushing is a silver color.*
5. Slide the hose over the barbed end on the master cylinder cartridge and install the hose nut.
6. Using a 10mm open-end wrench, torque the hose nut to 40 in-lb plus one full rotation.
7. Bleed the system.

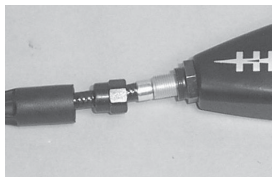

HFX-Mag Hose Assembly

A. Bleed Kit Assembly:

1. Screw the cap onto the end of the bottle.
2. Cut a 2" section of hose.
3. Push the short section of hose over the cap until it slides past the ridge on the cap.
4. Push the long section of hose into the master cylinder bleed fitting
Note: There are two fittings with the kit. The clear, cone shaped fitting is to be used with the HFX Mag and HFX Mag Plus. The silver aluminum fitting is to be used with the HFX-9.

B. Bleeding the System

Air entrapped in the hydraulic system of the disc brakes can decrease performance of the system and should be removed by "bleeding" the system and replenishing the system with new brake fluid. The system is filled by pumping fluid from the lowest point (at the caliper), through the system, to the highest point, the bleeder on the master cylinder.

Note: *The bleed instructions include steps for the HFX Mag and HFX-9 brake systems. Read them carefully, since instructions vary for the type of brake system you have.*

Caution: Use only new DOT 4 or DOT 3 brake fluid from a closed, sealed container. Use of any other fluid can cause the rubber parts to degrade and cause the brake to fail.

Caution: DOT 4 or DOT 3 brake fluid will strip paint. Use extreme caution to avoid getting DOT 4 or DOT 3 brake fluid on paint. If DOT 4 or DOT 3 brake fluid comes in contact with paint, wipe it off immediately and rinse with isopropyl alcohol.

Warning: If you get any brake fluid on the brake pads, discard them and replace with new pads. If you get any brake fluid on the disc, clean it thoroughly with isopropyl alcohol.

Warning: DOT 4 or DOT 3 brake fluid can be an irritant when it comes into contact with human tissue. For skin contact, brake fluid should be washed off in flowing water. For eye contact, the eye area should be irrigated with flowing water immediately and continuously for 15 minutes. Consult with medical personnel. If effects occur from inhaling brake fluid fumes, move to an area with fresh air. Consult a physician. If brake fluid is ingested, induce vomiting and consult medical personnel. Used brake fluid should be disposed of according to local laws.

1. Remove the wheel.
2. Remove the brake pads so that any spilled fluid does not contaminate the pads. Using the tab in the center of the pad backing plate, pull each pad toward the center of the caliper and out. There is a spring that holds the pad in place. That spring snaps on to the post at the center of the piston.
3. Push the caliper pistons all the way into their bores using the box end of a 10 mm end wrench.
Caution: Don't push on the post in the center of the piston because that will bend the post. Walk the piston back and forth until the piston is all the way back in the bore. Do the same thing on the other side.

Position the bike in a stand so that the brake caliper bleeder screw is perpendicular to the ground, and so that the bleed screw (HFX-Mag) or reservoir plug (HFX-9) on the master cylinder is the highest point on the brake system. This can be done by loosening the master cylinder clamp screws and rotating the master cylinder upright on the handlebars

Note: For the **HFX-Mag**, the bike should be in the stand with the front wheel higher than the rear at a 45-degree angle and the lever should point up at a 45-degree angle. For a left hand lever, turn the handlebars all the way to the right, and for the right hand lever, turn the handlebars all the way to the left.

Note: For the **HFX-9** the bike should remain horizontal to the ground, and the lever should remain parallel to the ground.



HFX-Mag



HFX-9

5. Remove the master cylinder bleed screw (HFX- Mag) or reservoir plug (HFX-9) and press the fitting with the hose into the hole. The other end of the hose should go into a cup or bottle to catch the excess fluid. Be sure not to submerge the end of the hose in fluid. Hint: Taping a spoke to a bottle and bending it to hook around the handlebars makes a convenient hanger.

Note: The HFX-Mag master cylinder bleed fitting is a Phillips head screw and requires the use of the clear cone shape bleed fitting included in the bleed kit.

Note: The HFX-9 master cylinder reservoir plug is a plastic cap, which needs to be removed with your fingers or a small flat head screwdriver. **DO NOT** remove the two T-10 Torx bolts holding the cap on. The HFX-9 requires the use of the silver aluminum bleed fitting included in the bleed kit.

6. Completely remove the caliper bleeder's rubber cap.
7. Fill the plastic filler bottle with fresh DOT 3 or DOT 4 brake fluid.
8. Close the caliper bleeder.
9. Place the hose from the fluid bottle onto the caliper bleeder. Pump the fluid bottle until there is no air in the hose.
10. Open the caliper bleeder 1/4 turn.
11. Squeeze the fluid bottle firmly—forcing fluid into the caliper for a count of five. Stop squeezing - until the bottle returns to its natural shape. When the squeeze is released, air should be drawn out of the caliper. Continue alternately squeezing the fluid bottle, for a count of five, and releasing until no air bubbles come out of the caliper.
12. After all the air is out of the caliper; squeeze the bottle until fluid comes out at master cylinder with no air bubbles.
13. While squeezing the bottle, quickly stroke the lever to the handlebars, and release. Repeat this until no more air bubbles come out of the master cylinder.
14. With the bottle still being squeezed, close the caliper bleeder. Torque should be only to seal the bleeder.

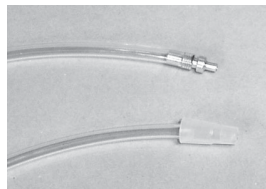

Bleed Fittings



Filler Bottle Attachment

Caution: Do not over torque! Then release and remove the bottle and filler hose.

Maintenance Procedures

Due to wear, contamination, or damage, the brake pads will, on occasion have to be replaced.

A. Brake Pad Change

1. Remove the wheel.
2. Using the tab in the center of the pad backing plate, pull the pad toward the center of the caliper and out. There is a spring that holds them in place. That spring snaps on to the post at the center of the piston.
3. Repeat the steps for the other side pad.

To replace the pads...

4. Using the boxed end of a 10mm wrench, push the caliper pistons back until they bottom. This will give you more room to fit in the new pads. Take care not to push on the aluminum post in the center of the piston.
Caution: Don't push on the post in the center of the piston because that will bend the post. Walk the piston back and forth until the piston is all the way back in the bore. Do the same thing on the other side.
Note: *There are two different brake pads, an inner and outer – or a right and a left. On the outer pad the tab is offset. On the inner pad the tab is in the center.*
5. Put the outer pad in first. Use the tab in the center of the pad backing plate to push the new pads into place. Angle the pad slightly so the post is towards the center of the caliper and push the pad until it snaps into place. Check that the pad is locked into position.
6. Now repeat the procedure for the outer pad.
7. Install the wheel.

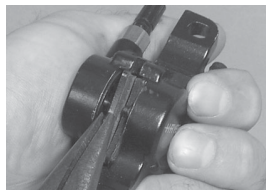

Removing Brake Pads



Pushing the Pistons Back

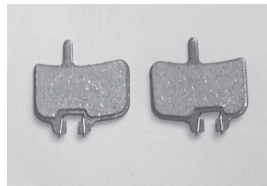

Outer and Inner Brake Pads

B. Piston(s) Pumped Out

If the brake lever is stroked without the disc between the pads (and this is possible when brake pads are being changed), the self-adjusting feature will allow the pads to push out. The caliper pistons will be pumped out of their bore. This will cause excessive drag on the disc when the wheel and disc are reinstalled, or even make it impossible to install the wheel and disc.

To fix this problem...

1. Remove the brake pads from the caliper if they are not already removed.
2. **Hint:** If the pads are pushed together tight, slide a series of thin cards between the pads to initiate a gap and enlarge the gap until it is large enough to pull the pads out. If you are going to replace the pads anyway, you can use a screwdriver instead of the cards to create the gap. But the screwdriver will break the friction material apart and the pads will definitely have to be discarded.
3. With the pads removed, push the pistons all the way back into the caliper using the box end of a 10 mm end wrench.
Caution: Don't push on the post in the center of the piston because that will bend the post. Walk the piston back and forth until the piston is all the way back in the bore. Do the same thing on the other side.
4. When the pistons are back into their bores, replace the pads – putting them in at a slight angle so that the spring catches the post on the piston.



C. Cleaning and Care

The brake disc and pads should only be cleaned with isopropyl alcohol (not disc brake cleaner).

Service

This service segment is designed to assist the reader with the service and repair of Hayes Disc Brakes. Read and be familiar with the instructions. The user should have a good knowledge of mechanical procedures, and should be equipped with proper tools and equipment. Incorrect service or repair may reduce braking performance, and could lead to a safety or personal hazard situation. If you have any doubts about the procedure described, due to limited experience or because of the lack of necessary tools and equipment, contact your local dealer or mechanic. Remember, always "Think Safety."

A. Troubleshooting

The following chart provides a quick reference as to the possible cause and the normal corrective action for the most common problems.

Problem	Possible Cause	Corrective Action
Lever goes to the handlebar	Bad Bleed Bad Cartridge System Leak	Re-bleed Replace Cartridge and re-bleed Look for leak and see "Fluid loss" below
Disc rubbing on the pads	Caliper not centered over disc Inadequate clearance Bent Disc	Re-center the caliper Push pistons back Replace Disc
Spongy Lever	Bad Bleed	Re-bleed
No braking power	Dirty disc Contaminated pads	Clean disc with alcohol Replace pads
Pads fall out	Bent or broken piston Bent or missing spring	Replace piston post Replace pads
Fluid loss	Banjo leaking Hose leaking Master cylinder bleeder Master cylinder cartridge	Replace banjo O-rings Tighten hose nut Replace hose Replace compression bushing Replace bleeder screw & O-ring Replace bleeder Rebuild master cylinder assembly

B. Tools

Box/Open end wrenches: 6mm, 8mm, 10mm, & 13mm,
Allen wrenches: 2.0mm, 4mm, & 5mm
Torque wrench: With 4mm, & 5mm bits, & Torx T25 Driver
Isopropyl alcohol
Hayes bleed kit
Bottle to catch drained fluid
Fresh DOT 4 or DOT 3 brake fluid
Small Phillips and flat screwdriver
Approved O-ring Lubricant
Hammer and Drift Punch

Warning: Always wear safety glasses when servicing the brake system or other components of your bike.

Torque Chart

Item	Torque
Disc Screws	50 +/- 5 in-lbs (5.65 +/- .55 Nm)
Handlebar Master Cylinder Clamp Screw	
HFX-Mag, HFX-Mag Plus :	15-20 in-lbs (1.7-2.26 Nm)
HFX-9 :	30-35 in-lbs. (3.39-3.95 Nm)
Master Cylinder Jam Nut	50 in-lbs +/- 5 in-lbs (5.65 +/- .55 Nm)
Caliper Bleeder	2.0 in-lbs (.23 Nm)
	(Torque to seal. Do not overtorque)
Caliper Bridge Bolts	110 +/- 10 in-lbs (12.43 +/- 1.1 Nm)
Caliper Mount Bolts	110 +/- 10 in-lbs. (12.43 +/- 1.1 Nm)
Hose Connection	
Master Cylinder	
HFX-Mag, HFX-Mag Plus	40 in-lbs (4.52 Nm) + 1 full rotation
HFX-9	60 +/- 5 in-lbs (6.78 +/- .55Nm)
Caliper :	
G1 :	40 in.-lbs. (4.52 Nm) + 1 full rotation
2003 G2	60 +/- 5 in-lbs (6.78 +/- .55Nm)

Warranty

Any Hayes Disc Brake found by the factory to be defective in materials and/or workmanship within two years from the date of purchase will be repaired or replaced at the option of the manufacturer, free of charge, when received at the factory with proof of purchase, freight prepaid. This includes assembly costs (for instance by the dealer), which shall not be covered by Hayes Disc Brake. This warranty does not cover breakage, bending, or damage that may result from crashes or falls. This warranty does not cover any defects or damage caused by alterations or modifications of new Hayes disc Brakes or parts or by normal wear, accidents, improper maintenance, damages caused by the use of parts of different manufacturers, improper use or abuse of the product, or failure to follow instructions contained in an instruction manual for Hayes Disc Brake. Any modifications made by the user will render the warranty null and void. The cost of normal maintenance or replacement of service items, which are not defective, shall be paid for by the original purchaser. This warranty is expressly in lieu of all other warranties, and any implied are limited in duration to the same duration as the expressed warranty herein. Hayes Disc Brake shall not be liable for any incidental or consequential damages.

If for any reason warranty work is necessary, return the brake to the place of purchase. In the USA, contact Hayes Disc Brake for a return authorization number (RA #) at (888) 686-3472. At that time, instructions for repair, return, or replacement shall be given. Customers in countries other than USA should contact their dealer or local Hayes Disc Brake distributor.

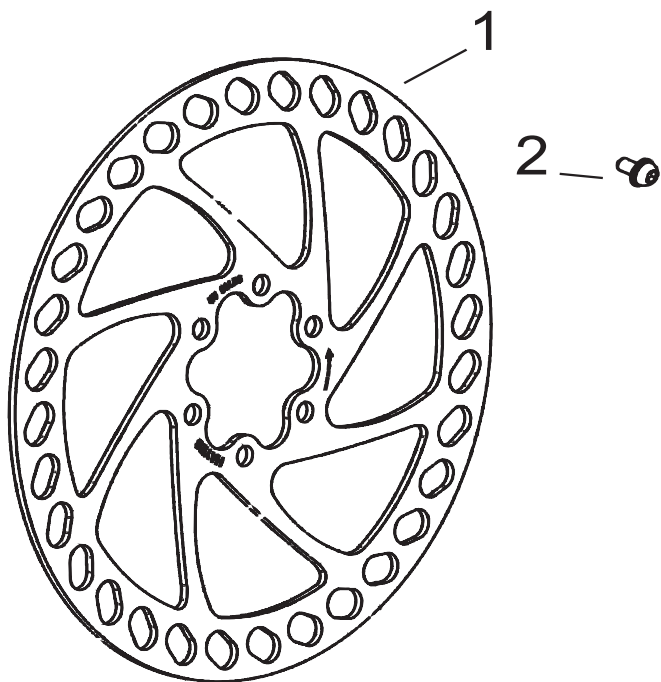

Disc

Item	Description	Quantity
1	6 bolt pattern, 6" disc	1
1	6 bolt pattern, 8" disc	1
1	4 bolt pattern, 6" disc	1
2	Disc Screw	4 or 6

HFX-9

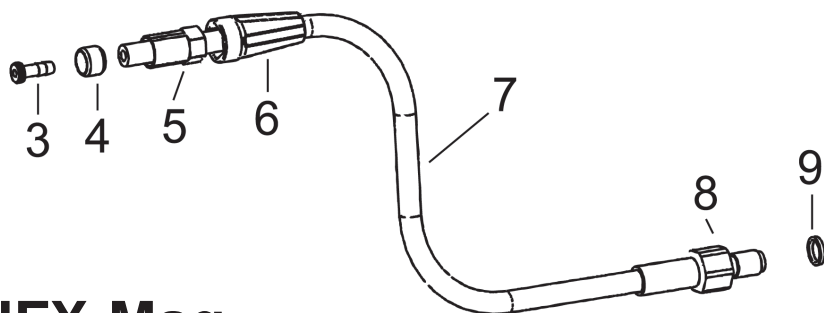

HFX-Mag

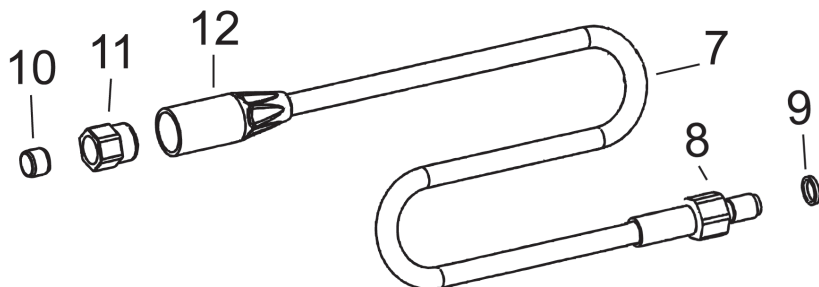

Hose

Item	Description	Quantity
HFX-9 (G2)		
3	Hose Insert	1
4	Compression Bushing	1
5	Hose Nut	1
6	Nose Cone	1
7	Hose	1
8	Hose Connection	1
9	Hose Connection Seal	1
HFX-Mag (G2)		
7	Hose	1
8	Hose Connection	1
9	Hose Connection Seal	1
10	Compression Bushing	1
11	Hose Nut	1
12	Nose Cone	1

Caliper Components

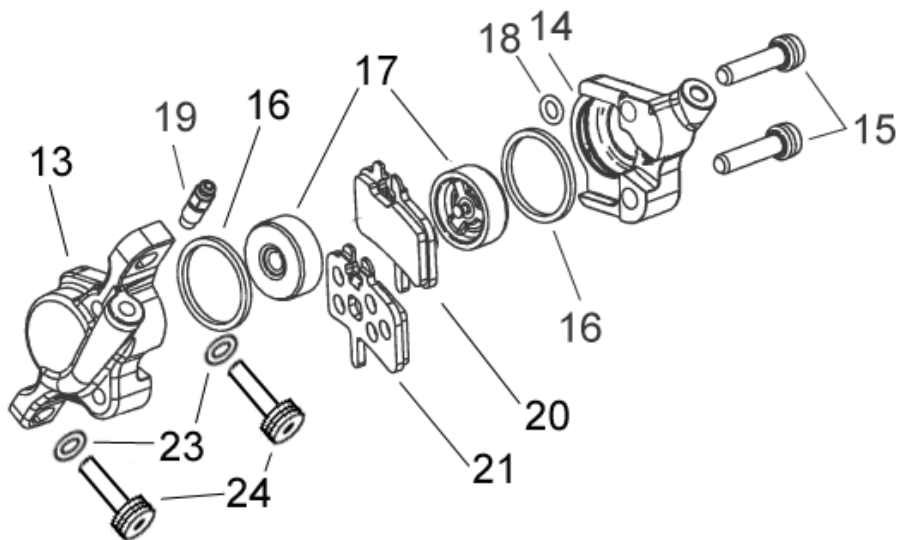

Caliper (G2)

Item	Description	Quantity
13	Caliper, Outer	1
14	Caliper, Inner	1
15	Bridge Bolt	2
16	Square Seal	2
17	Caliper Piston	2
18	Transfer Port O-ring	1
19	Caliper Bleed Screw	1
20	Pad, Inner	1
21	Pad, Outer	1
22	Mounting Bolt	2
23	Washer	2

Master Cylinder Components

HFX-Mag

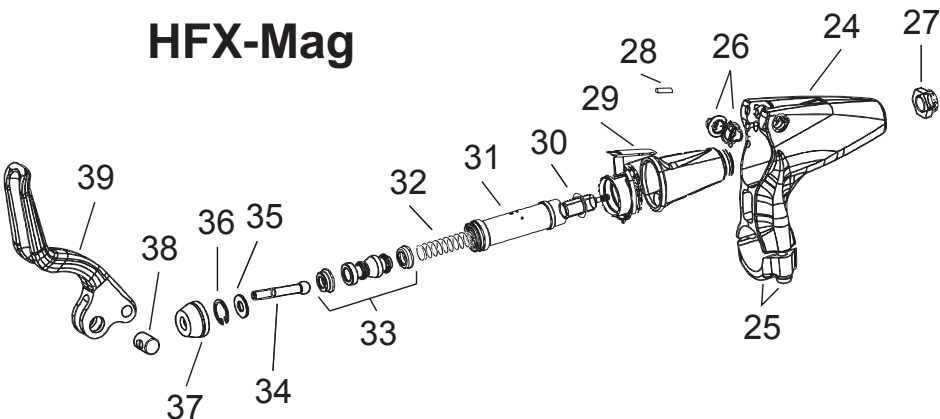

Master Cylinder

Item	Description	Quantity
HFX-Mag		
24	Lever Body	1
25	Clamp Screws	2
26	Lever Pin Bushing	1
27	Jam Nut	1
28	Lever Pin	1
29	Bladder Retainer	1
30	Cartridge Gasket	1
31	Cartridge	1
32	Return Spring	1
33	Master Cylinder Piston with Cups	1
34	Push Rod	1
35	Retaining Washer	1
36	Retaining Ring	1
37	Push Rod Seal	1
38	Adjuster Bushing	1
39	Lever	1
HFX-9		
32	Return Spring	1
33	Master Cylinder Piston with Cups	1
34	Push Rod	1
35	Retaining Washer	1
36	Retaining Ring	1
38	Adjuster Bushing	1
40	Master Cylinder Body	1
41	Clamp Screw	2
42	Reservoir Cap Screws	2
43	Reservoir Plug	1
44	Reservoir Cap	1
45	Bladder	1
46	Lever Pin Bushings	2
47	Lever Pin	1
48	Lever	1

Master Cylinder Components

HFX-9

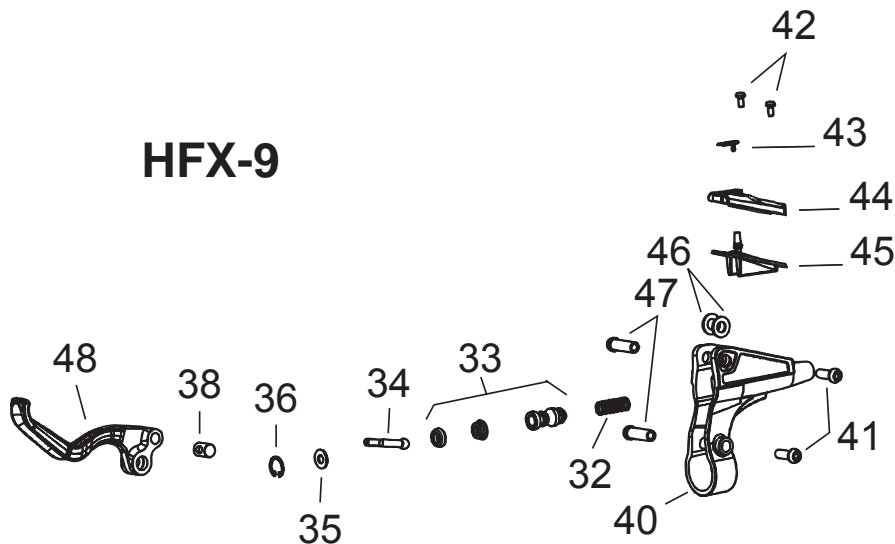

Master Cylinder

Item	Description	Quantity
HFX-Mag		
24	Lever Body	1
25	Clamp Screws	2
26	Lever Pin Bushing	1
27	Jam Nut	1
28	Lever Pin	1
29	Bladder Retainer	1
30	Cartridge Gasket	1
31	Cartridge	1
32	Return Spring	1
33	Master Cylinder Piston with Cups	1
34	Push Rod	1
35	Retaining Washer	1
36	Retaining Ring	1
37	Push Rod Seal	1
38	Adjuster Bushing	1
39	Lever	1
HFX-9		
32	Return Spring	1
33	Master Cylinder Piston with Cups	1
34	Push Rod	1
35	Retaining Washer	1
36	Retaining Ring	1
38	Adjuster Bushing	1
40	Master Cylinder Body	1
41	Clamp Screw	2
42	Reservoir Cap Screws	2
43	Reservoir Plug	1
44	Reservoir Cap	1
45	Bladder	1
46	Lever Pin Bushings	2
47	Lever Pin	1
48	Lever	1

Mount Brackets

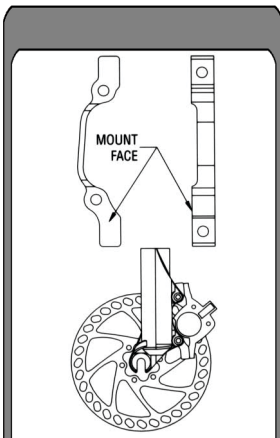

International Standard Front Q/R
6" Disc
Standard Quick Release Hub
Part # 98-15068

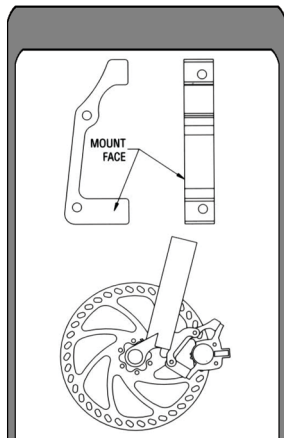

International Standard Front 20mm
8" Disc
20 mm Hub
Part # 98-15069

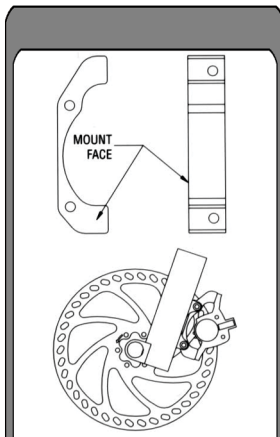

Rock Shox Boxxer
8" Disc
20mm Hub
Part # 98-15071

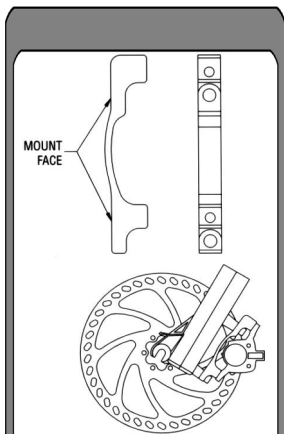

Manitou Sherman
8" Disc
20mm or Standard Quick Release
Part # 98-15072

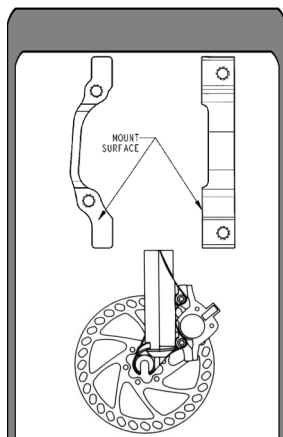

International Standard Front 20mm
6" Disc
20mm Hub
Part # 98-15282

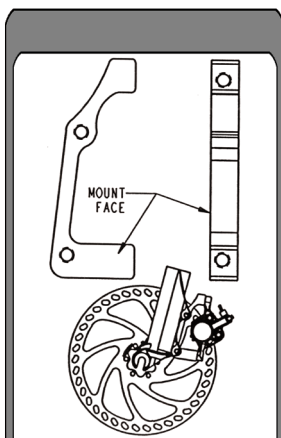

Rock Shox Psylo 8"
8" Disc
20mm or Standard Quick Release
Part # 98-15604

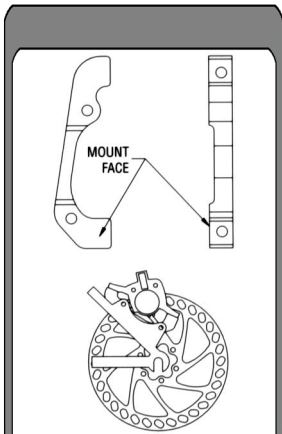

International Standard Rear
6" Disc
Part # 98-15073

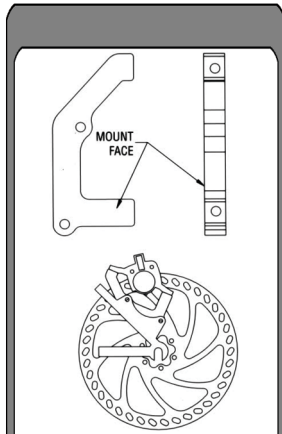

International Standard Rear
8" Disc
Part # 98-15074

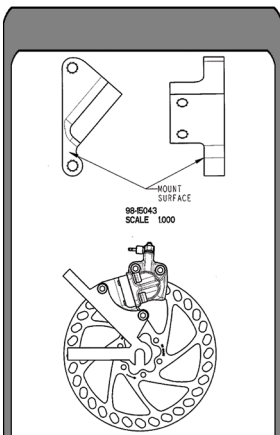

International Standard Rear
22mm Caliper / 6" Disc
Part # 98-15281