

BUBBA | BUBBA X
SUPER BUBBA | SUPER BUBBA X
SETUP AND SERVICE GUIDE



SUNRINGLE

5800 W Donges Bay Rd
Mequon, WI 53092

sun-ringle.com

888.686.3472

Support: sun-ringle.com/support

WARRANTY

For full warranty information please
visit hayesbicycle.com/warranty

HAYES

m
manitou

PROTAPER

REYNOLDS

SUN
ringle

WHEELSMITH
W
SPOKES

HAYES
PERFORMANCE SYSTEMS

INTRODUCTION

This manual is intended to provide the information necessary to service the SUNringle Bubba / Super Bubba and Bubba X / Super Bubba X Hubs. We highly recommend installation be performed by a qualified mechanic. These instructions can be downloaded from the SUNringle website at www.hayesbicycle.com

⚠ WARNING ⚠

We highly recommend that service to this hub be performed by a certified bicycle mechanic. Failure to follow instructions presented in this manual could lead to serious injury or death. Any questions about the servicing of product or the manual itself should be directed to Hayes Customer Support at:

Hayes Bicycle USA	5800 W Donges Bay Road Mequon WI 53092
	Phone: 888.686.3472
	Email: techsupport@hayesbicycle.com

Hayes Bicycle Europe	Dirnismaning 20 a 85748 Garching (b. Munich) Germany
	Phone: +49 89 203237450
	Email: techsupportEU@hayesbicycle.com

Hayes Bicycle Asia	16F, No. 37, Sec. 3 Mincyuan E. Rd. Zhongshan District Taipei City 10476 Taiwan ROC
	Phone: 886-2-2518-1108

TABLE OF CONTENTS

SECTION	PAGE NUMBER
Tools And Materials	5
Hub Disassembly	6-8
Freehub Body Disassembly	9-10
Bearing Removal	11
Bearing Installation	12
Freehub Body Assembly	13-14
Hub Rebuild	15-18
Exploded Views	19-26

TOOLS AND MATERIALS

Below is a list of tools and materials necessary for Servicing Super Bubba hubs.

- Two pin spanner (Example: Part Tool SPA-2)
- 90 degree pick tool
- High quality bicycle grease
- Freehub Body grease (Dumonde Tech Freehub Body Grease recommended)
- Freehub Body oil (Dumonde Tech Freehub Body Oil recommended)
- Bearing puller OR hammer and punch
- Bearing press

HUB DISASSEMBLY

- 1 Remove the wheel from the frame, remove cassette and rotor. Remove the end caps by gently pulling them away from the hub.

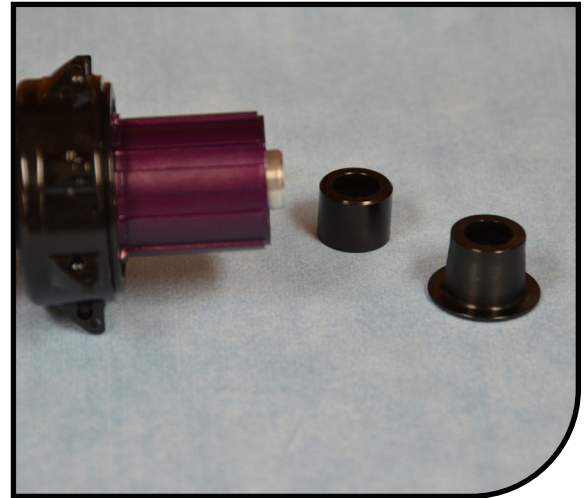

- 2 Slide off the Freehub Body by gently pulling away from the hubshell. (If hard to remove lightly turn the Freehub Body counter clockwise it is pulled.)



- 3 Remove the crush tube.

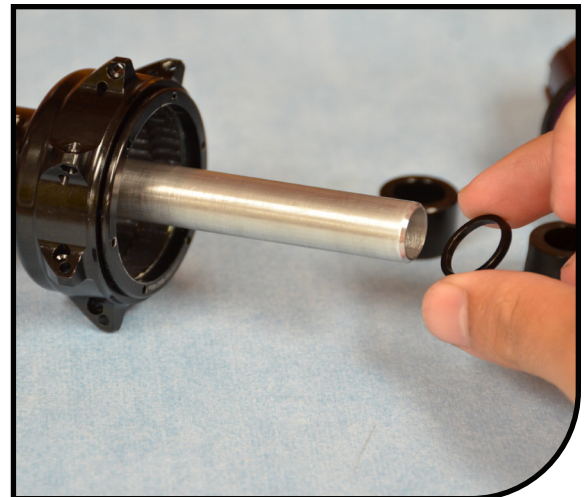

HUB DISASSEMBLY

- 4** Remove axle by sliding it out of the hub. Axle can be removed out of either side of the hub shell.

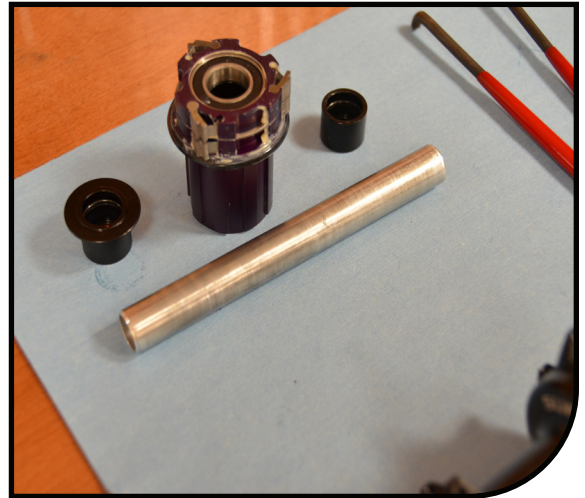

- 5** Remove lock ring with pin spacer. The lock ring is left hand thread.

Note: if you are having a hard time removing the lock ring attach two disk screws in the hub 180 degrees from each other, use these to hold the hub in a vise.



- 6** Using the 90 Degree pick tool pry out the top ratchet ring.
NOTE: Bubba X and Super Bubba X only use one ratchet ring.

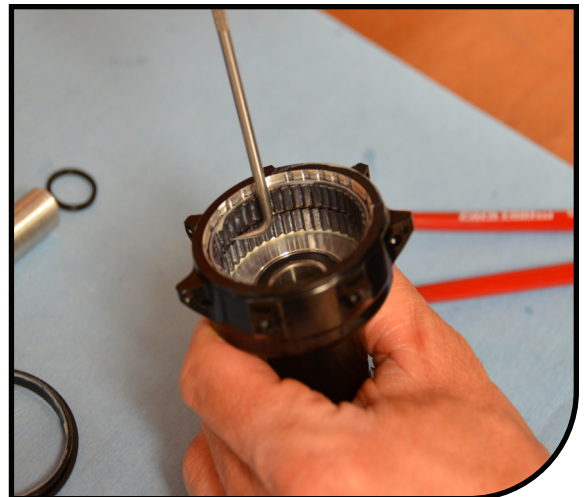

HUB DISASSEMBLY

- 7 Remove the bottom ratchet ring as well with the pick tool.



FREEHUB DISASSEMBLY

- 1 Remove the first set of Pawls and springs, three of each, they will slide out by hand. **Note: Bubba X and Super Bubba X have one row of 6 pawls**

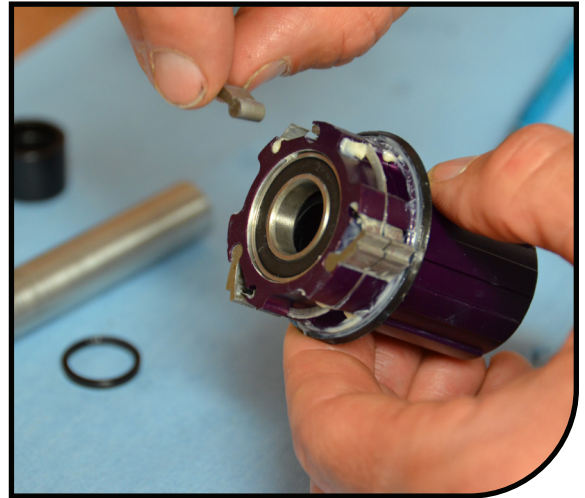

- 2 Remove the pawl split ring with the pick tool. **Note: Bubba X and Super Bubba X do not use a split ring.**

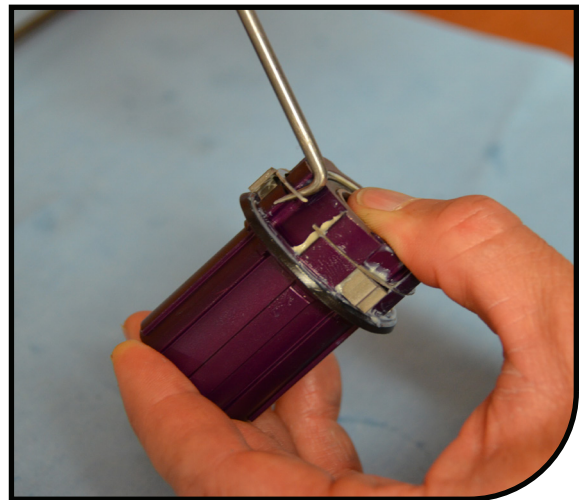

- 3 Slide out the second set of Pawls and springs.



FREE HUB DISASSEMBLY

- 4 Remove the seal from the drive side of the Free hub body.



BEARING REMOVAL

- 1 Pull out the non-drive side (NDS) bearing from the hub, behind this bearing is a spacer.



- 2 Pull out the drive side bearing.



- 3 Pull out the inner bearing on the freehub body, behind this bearing is a spacer.

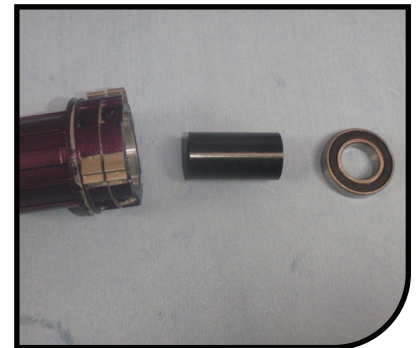

- 4 Pull out the outer bearing on the freehub body.

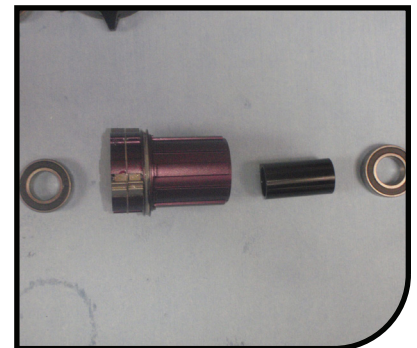

BEARING INSTALLATION

- 1 Lightly grease the new bearing with high quality bicycle grease. Press in bearing into the Non-drive side (NDS) of the Hub.



- 2 Install the spacer, lightly grease and press in the driver side (DS) bearing.



- 3 Lightly grease and press in the drive side (DS) bearing on the freehub body.

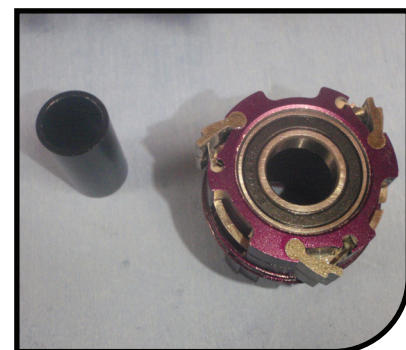

- 4 Install the spacer, lightly grease and press in the none drive side (NDS) bearing.



FREEHUB ASSEMBLY

- 1 Lightly lubricate the pawl seats with Freehub Body grease. Install the lower set of springs and Pawls. **Note: Bubba X and Super Bubba X have one row of 6 pawls**



- 2 Install the Pawl split ring onto the free hub.



- 3 Install the upper set of springs and Pawls.



FREEHUB ASSEMBLY

- 4 Install the seal on the freehub body (note the lip must face out toward the cassette)

Note: the seal must sit in its groove without being twisted or you will experience a high drag)

Lubricate with pawls and springs with free hub Body grease for quieter operation and longer service life, use free hub oil for louder operation and improved low temperature operation.

Lightly lubricate seal with free hub oil.

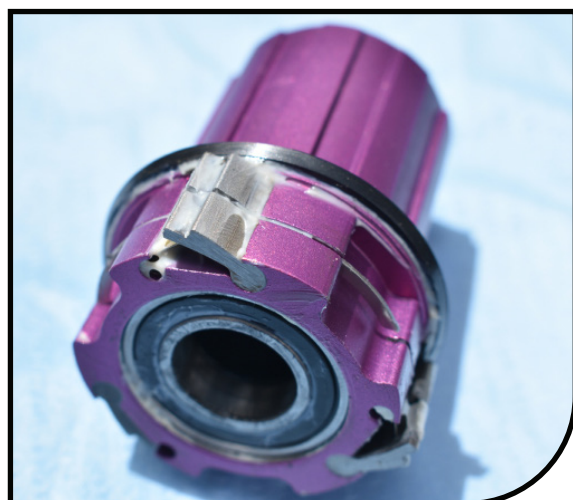

HUB REBUILD

- 1 Lightly grease the outside of the ratchet ring with high quality bicycle grease. With the groove facing outward slide the first ratchet ring down into the hub, make sure you have the first lobe of the ratchet ring in the first notch of the hub. **NOTE: Bubba X and Super Bubba X only use one ratchet ring.**

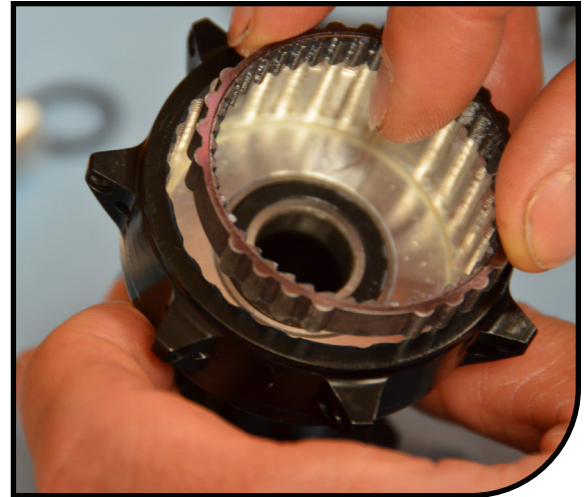

- 2 For 8 degrees of engagement install the second ratchet ring, with the groove up, with the first lobe on the ratchet ring in the first notch of the hub.

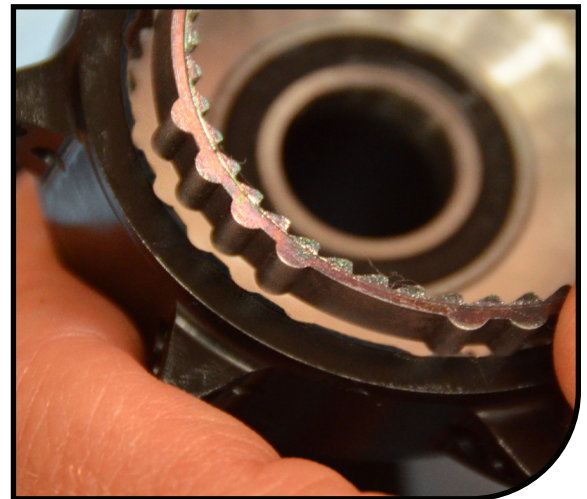

- 3 For 4 degrees of engagement install the second ratchet ring, with the groove up, with the first lobe on the ratchet ring in the second notch of the hub.

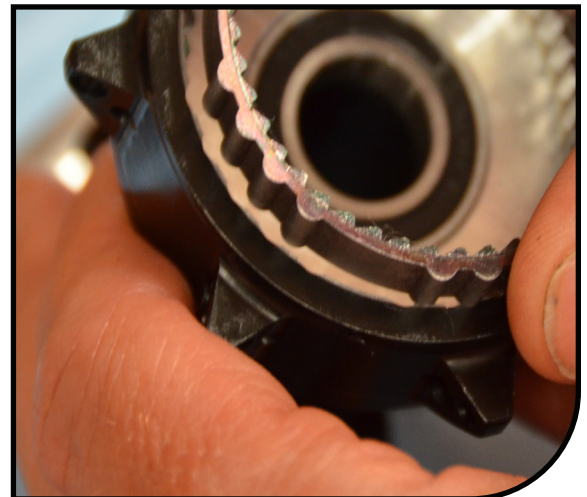

HUBREBUILD

- 4 Reinstall the ratchet ring with the pin spanner tool.

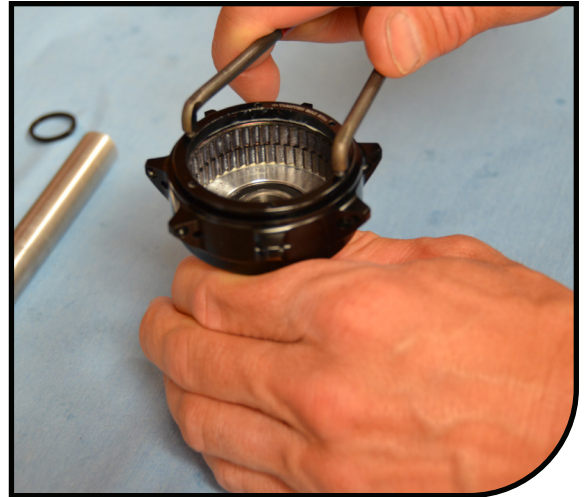

- 5 Lightly grease the outside of the axle with a high quality bicycle grease. Slide the axle back into the hub.



- 6 Install the crush tube.



HUBREBUILD

- 7** Install the Free Hub Body onto the axle.



- 8** Once the freehub body is resting on the hub, depress all three pawls of the first set and push down, this will allow the freehub to move into the hub up to the second set of pawls. If the freehub body is difficult to install, gently rotate counter clockwise as it is pushed into the hub shell. Repeat for the second set of pawls. **Note: Bubba X and Super Bubba X have one row of 6 pawls**



- 9** Repeat step 8 with the second set of Pawls. If the freehub body is difficult to install, gently rotate counter clockwise as it is pushed into the hub shell.

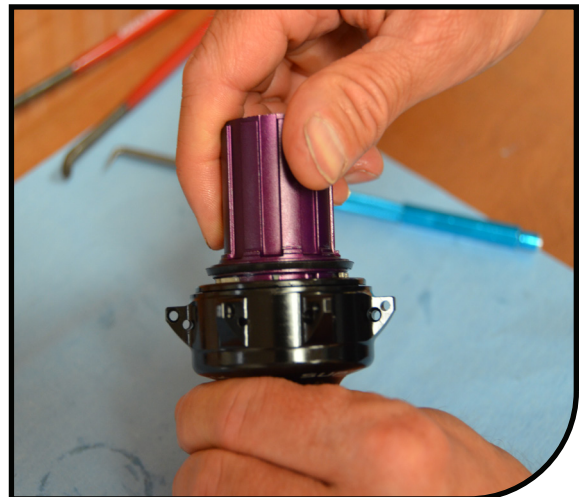

HUBREBUILD

- 10** Press the freehub body down fully making sure the seal does not get folded over.

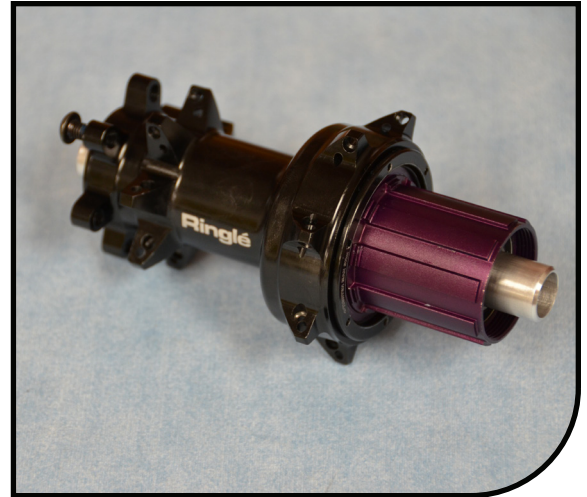

- 11** Press the none drive side (NDS) end cap on, press till the cap touches the hub bearing, this sets the axle.

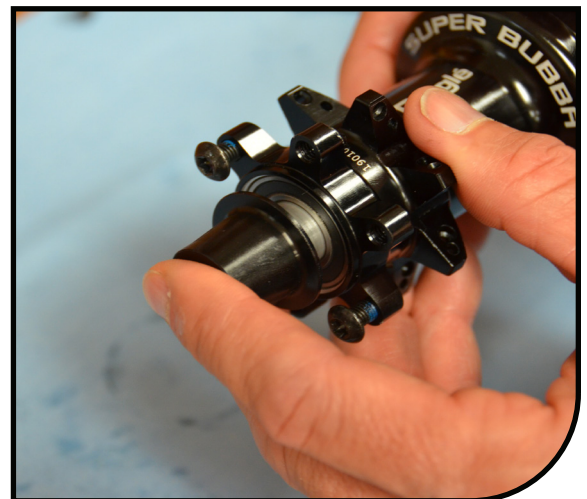

- 12** Press on the drive side (DS) endcap.



EXPLODED VIEW BUBBA DH FRONT HUB

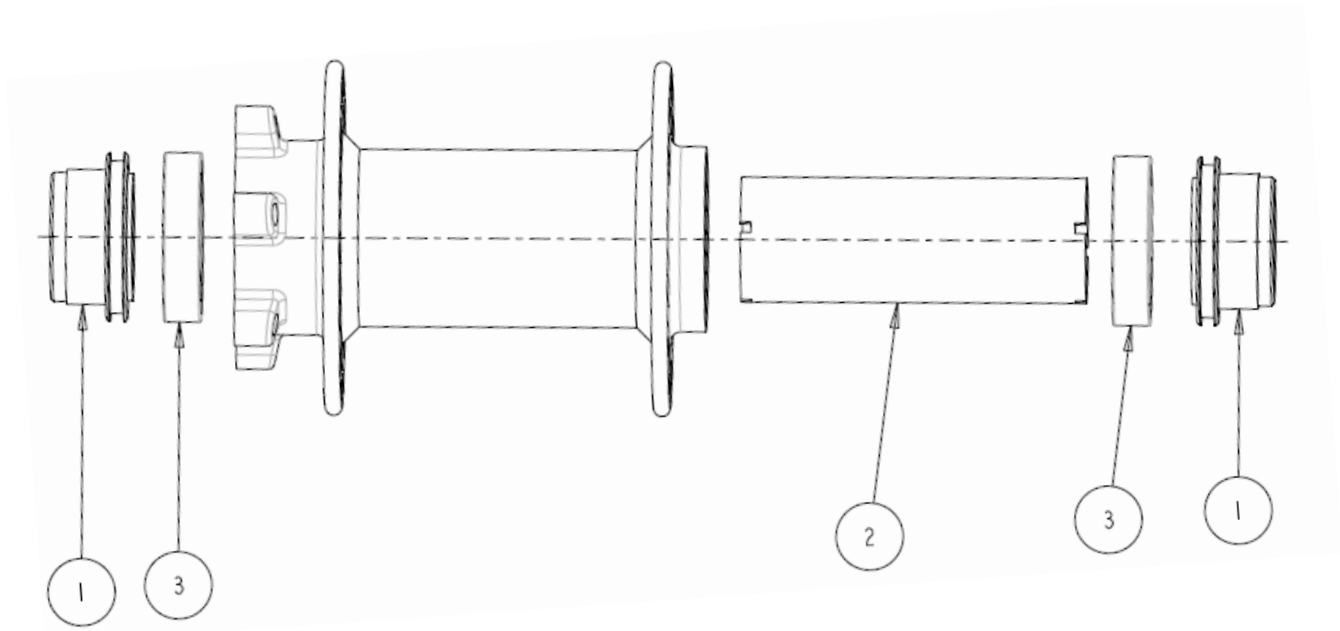

	Description	Part #
1	Bubba DH 110x20 Boost F End Cap Kit - Pair	281-37249-K006
2	Bubba DH Front hub shell spacer tube Kit	281-37253-K004
3	Bubba DH Front 6804 Bearing Kit - qty 2	281-37254-K003

EXPLODED VIEW FRONT HUBS

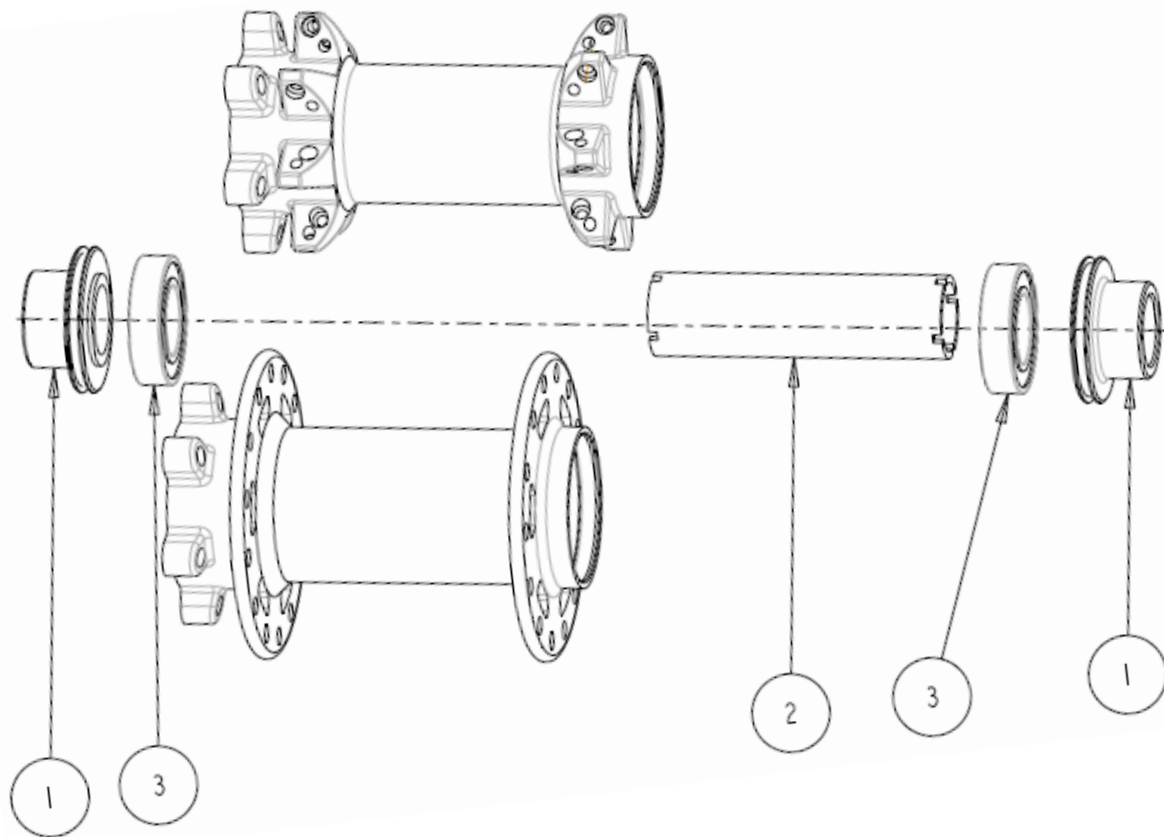

	Description	Part #
1	Bubba 15x110 F End Cap Kit - Pair	281-37249-K001
	Bubba 15x110 F End Cap Kit Torque Cap -Pair	281-37249-K002
2	Bubba Front hub shell spacer tube Kit	281-37253-K001
3	Bubba/Bubba X 6902 Bearing Kit -qty 2	281-37254-K001

EXPLODED VIEW SUPER BUBBA CENTERLOCK FRONT HUB

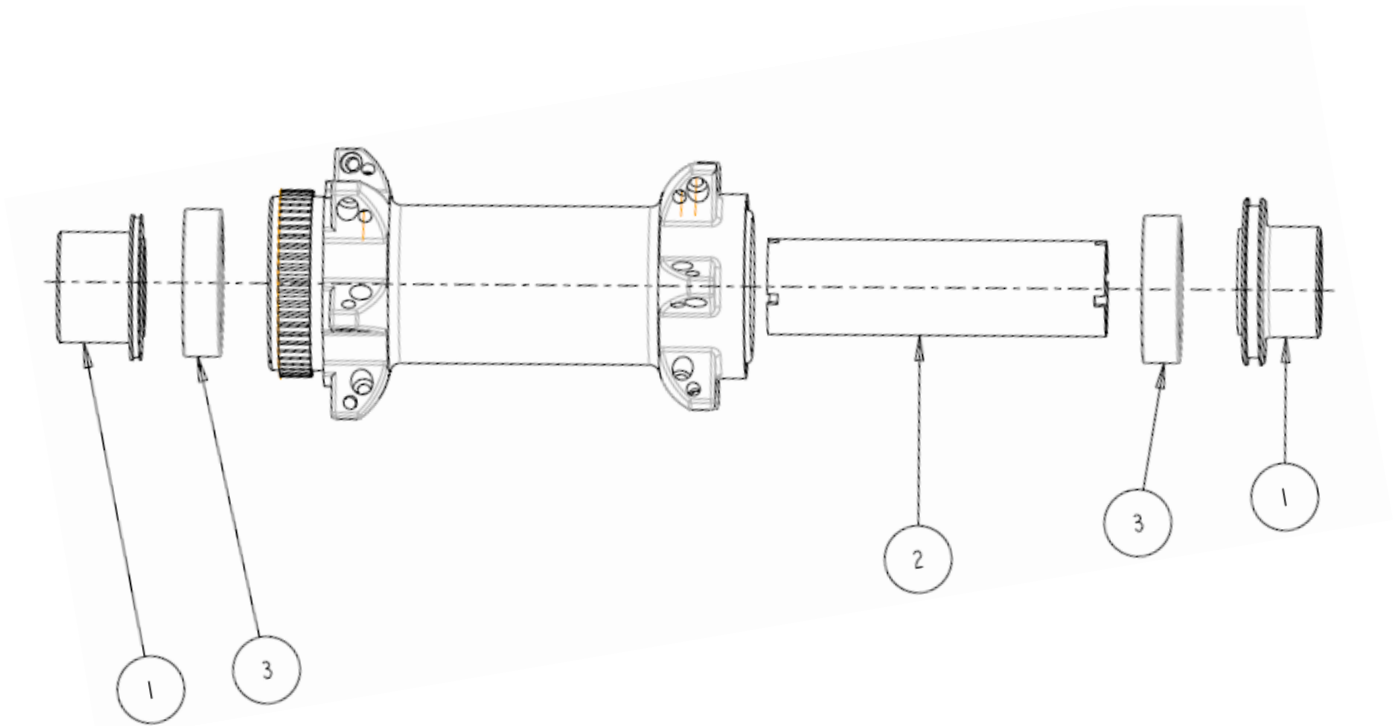

	Description	Part #
1	Bubba CL 110x15 Front End Cap Kit Pair	281-37249-K007
2	Bubba CL 110x15 F hub shell spacer tube Kit	281-37253-K005
3	Bubba/Bubba X 6902 Bearing Kit -qty 2	281-37254-K001

EXPLODED VIEW SUPER BUBBA X CL 100 FRONT HUB

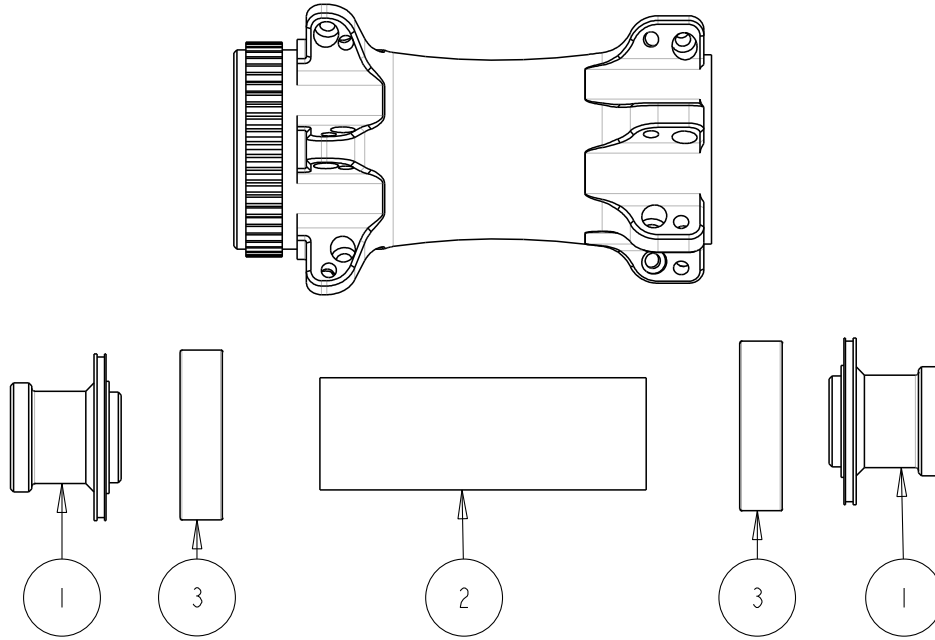

	Description	Part #
1	SRX CL 100/110 Bubba CL100 F 12mm Cap Kt	281-31519-K018
	SRX CL 100/110 Bubba CL100 F 15mm Cap Kt	281-31519-K017
2	SRX/Bubba CL F Hub Spacer Tube Kit 100mm	281-32015-K005
3	Bubba/Bubba X 6902 Bearing Kit -qty 2	281-37254-K001

EXPLODED VIEW SUPER BUBBA AND BUBBA REAR HUB

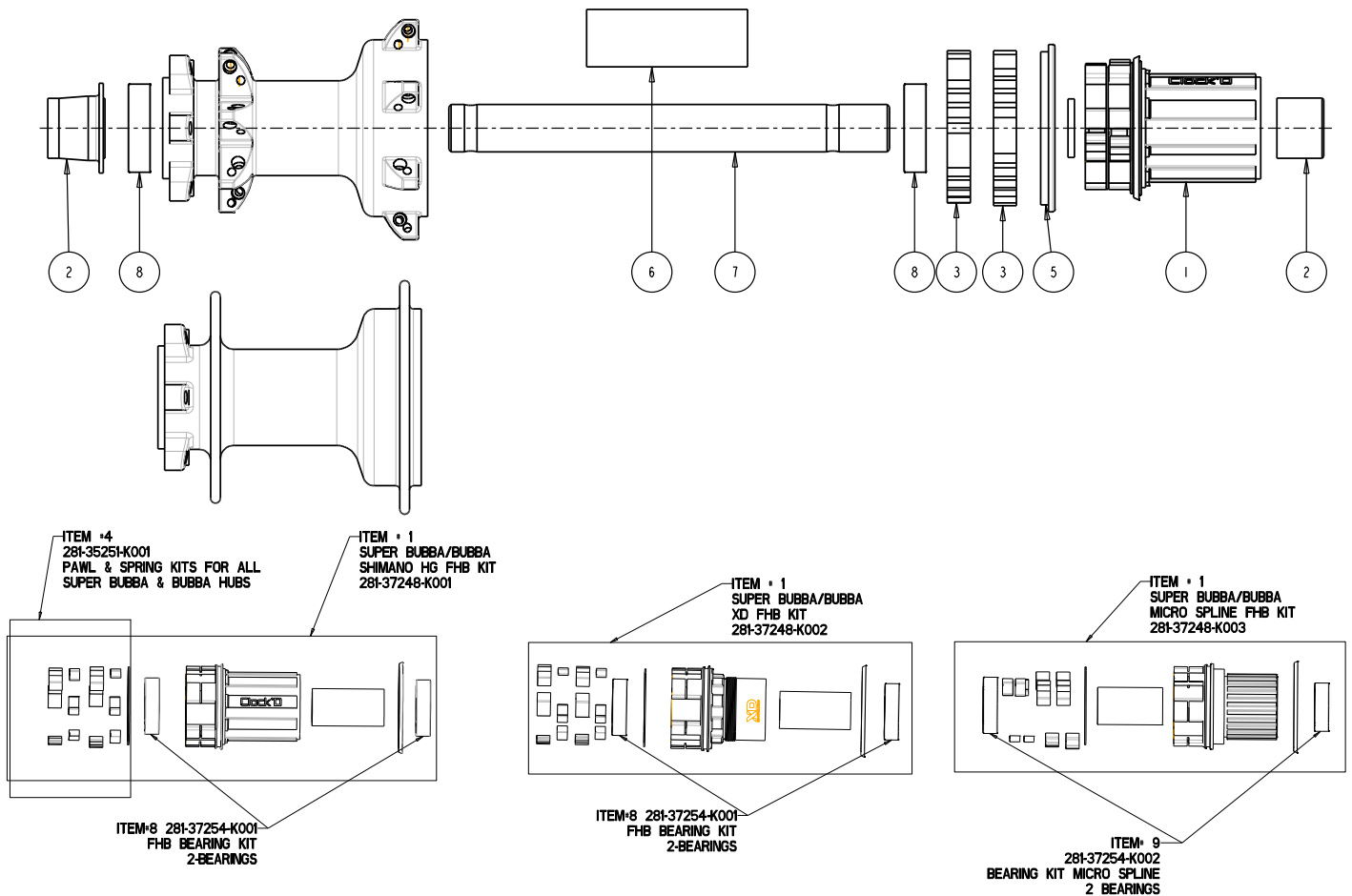

Description		Part #
1	Bubba FH Body Kit - Shimano HG Alloy	281-37248-K001
	Bubba FH body Kit - SRAM XD Alloy	281-37248-K002
	Bubba FH Body Kit - Shimano MS Alloy	281-37248-K003
2	Bubba/Bubba X 148/157x12 R Cap Pair HG	281-37249-K003
	Bubba/Bubba X 148/157x12 R Cap Pair XD	281-37249-K004
	Bubba/Bubba X 148/157x12 R Cap Pair MS	281-37249-K005
3	Bubba Ratchet ring kit - Qty 2	281-37250-K001
4	Bubba/Bubba X Pawl Kit	281-37251-K001
5	Bubba/Bubba X Locking ring kit	281-37255-K001
6	Bubba 148 R hub shell spacer tube Kit	281-37253-K002
	Bubba 157 R hub shell spacer tube Kit	281-37253-K007
7	Bubba/Bubba X 148x12 Axle Kit - Alloy	281-37256-K001
	Bubba/Bubba X 148x12 Axle Kit - Steel	281-37256-K002
8	Bubba/Bubba X 157x12 Axle Kit - Alloy	281-37256-K003
9	Bubba/Bubba X 157x12 Axle Kit - Steel	281-37256-K004
	Bubba/Bubba X 6902 Bearing Kit -qty 2	281-37254-K001
	Bubba/Bubba X MS FH Bearing Kit	281-37254-K002

EXPLODED VIEW BUBBA X AND SUPER BUBBA X

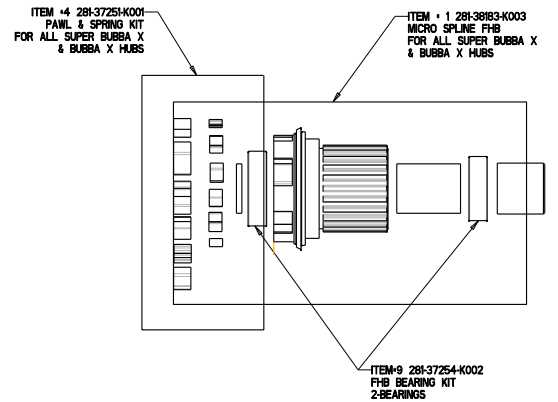
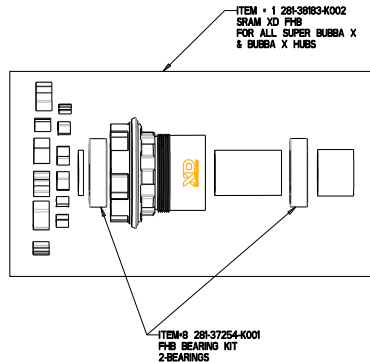
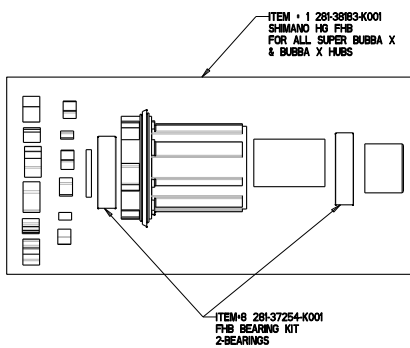
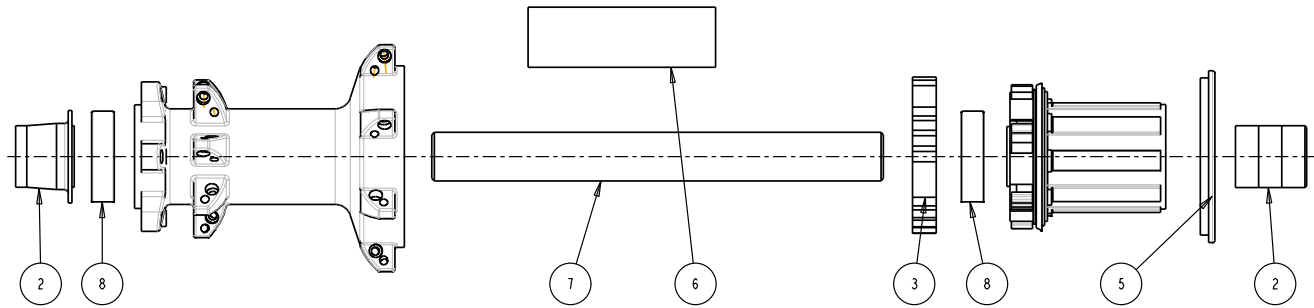

Description		Part #
1	Bubba X FH Body Kit - Shimano HG Alloy	281-38183-K001
	Bubba X FH body Kit - SRAM XD Alloy	281-38183-K002
	Bubba X FH Body Kit - Shimano MS Alloy	281-38183-K003
2	Bubba/Bubba X 148/157x12 R Cap Pair HG	281-37249-K003
	Bubba/Bubba X 148/157x12 R Cap Pair XD	281-37249-K004
	Bubba/Bubba X 148/157x12 R Cap Pair MS	281-37249-K005
3	Bubba X Ratchet ring kit - Qty 1	281-37250-K002
4	Bubba/Bubba X Pawl Kit	281-37251-K001
5	Bubba/Bubba X Locking ring kit	281-37255-K001
6	Bubba X 148 Rear hub shell spacer tube Kit	281-37253-K003
7	Bubba/Bubba X 148x12 Axle Kit - Alloy	281-37256-K001
	Bubba/Bubba X 148x12 Axle Kit - Steel	281-37256-K002
	Bubba/Bubba X 157x12 Axle Kit - Alloy	281-37256-K003
8	Bubba/Bubba X 157x12 Axle Kit - Steel	281-37256-K004
9	Bubba/Bubba X 6902 Bearing Kit -qty 2	281-37254-K001
	Bubba/Bubba X MS FH Bearing Kit	281-37254-K002
	Bubba/Bubba X MS FH Bearing Kit	281-37254-K002

EXPLODED VIEW SUPER BUBBA X CENTERLOCK

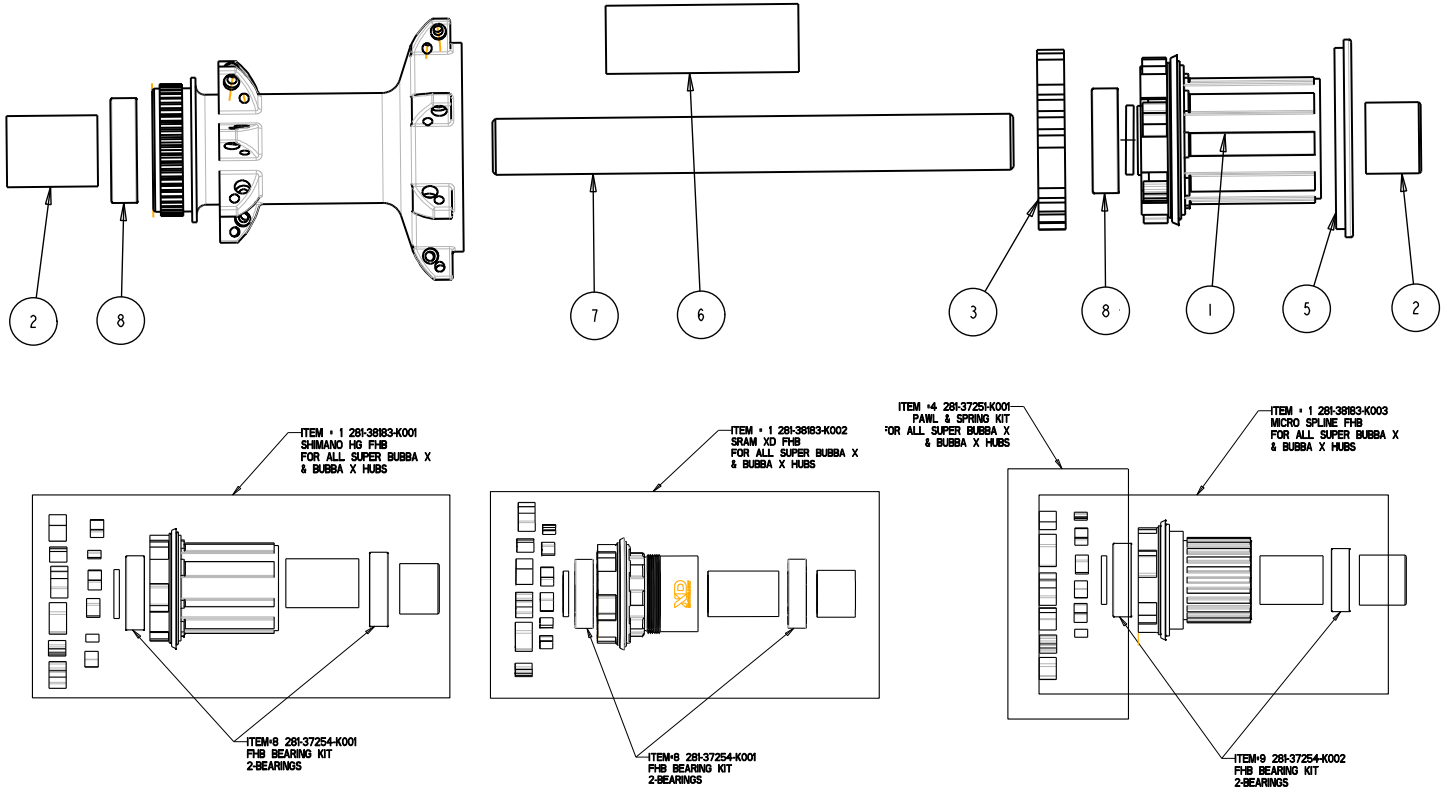

Description		Part #
1	Bubba X FH Body Kit - Shimano HG Alloy	281-38183-K001
	Bubba X FH body Kit - SRAM XD Alloy	281-38183-K002
	Bubba X FH Body Kit - Shimano MS Alloy	281-38183-K003
2	Bubba X CL 12mm Rear End Cap Pair HG	281-37249-K008
	Bubba X CL 12mm Rear End Cap Pair XD	281-37249-K009
	Bubba X CL 12mm Rear End Cap Pair MS	281-37249-K010
3	Bubba X Ratchet ring kit - Qty 1	281-37250-K002
4	Bubba/Bubba X Pawl Kit	281-37251-K001
5	Bubba/Bubba X Locking ring kit	281-37255-K001
6	Bubba X CL 148 R hub sheel space tube kit	281-37253-K006
7	Bubba/Bubba X 148x12 Axle Kit - Alloy	281-37256-K001
	Bubba/Bubba X 148x12 Axle Kit - Steel	281-37256-K002
	Bubba/Bubba X 157x12 Axle Kit - Alloy	281-37256-K003
8	Bubba/Bubba X 157x12 Axle Kit - Steel	281-37256-K004
9	Bubba/Bubba X 6902 Bearing Kit -qty 2	281-37254-K001
	Bubba/Bubba X MS FH Bearing Kit	281-37254-K002
	Bubba/Bubba X MS FH Bearing Kit	281-37254-K002

EXPLODED VIEW SUPER BUBBA X CL 142 REAR HUB

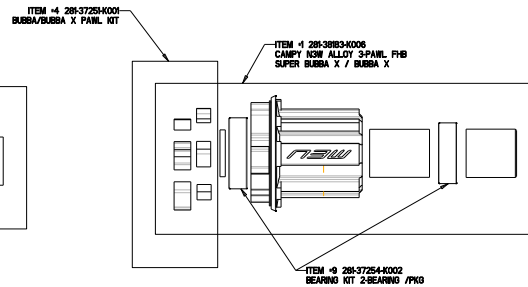
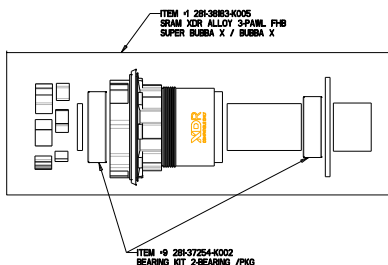
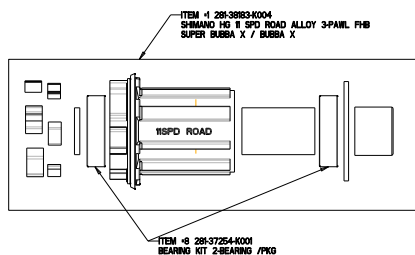
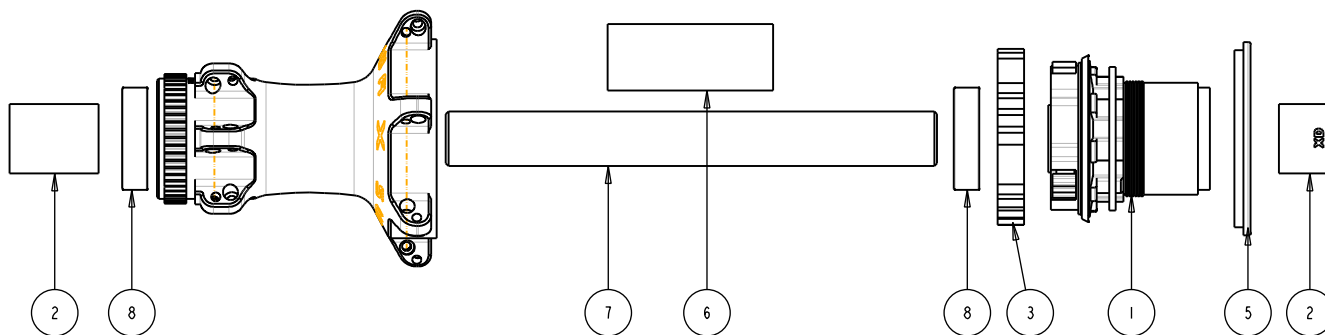

Description		Part #
1	Bubba X FH Body Kit - Shimano HG R Alloy	281-38183-K004
	Bubba X FH Body Kit - SRAM XDR Alloy	281-38183-K005
	Bubba X FH Body Kit - Campy N3W Alloy	281-38183-K006
2	Bubba X CL 12mm Rear End Cap Pair HG	281-37249-K008
	Bubba X CL 12mm Rear End Cap Pair XD	281-37249-K009
	Bubba X CL 12mm Rear End Cap Pair N3W	281-37249-K012
3	Bubba X Ratchet ring kit - Qty 1	281-37250-K002
4	Bubba/Bubba X Pawl Kit	281-37251-K001
5	Bubba/Bubba X Locking ring kit	281-37255-K001
6	Bubba X CL 142 R hub shell spacer tube kit	281-37253-K008
7	Bubba X CL 142x12 Axle Kit - Alloy	281-37256-K005
8	Bubba/Bubba X 6902 Bearing Kit -qty 2	281-37254-K001
9	Bubba/Bubba X MS/N3W/XDR FH Bearing Kit	281-37254-K002

GLOBAL HEADQUARTERS & HAYES BICYCLE GROUP USA

5800 W. Donges Bay Rd.
Mequon, WI 53092

HAYES BICYCLE GROUP EU

Dirnismaning 20 a
85748 Garching (b. Munich)
Germany

HAYES BICYCLE GROUP ASIA

16F, No. 37, Sec. 3
Mincyuan E. Rd.
Zhongshan District

facebook.com/SunRingle



instagram.com/SunRingleWheels



#100PercentTrue

HAYES

M
manitou

PROTAPER

REYNOLDS

SUN
ringle

WHEELSMITH
W
SPORES

HAYESBICYCLE.COM

HAYES
PERFORMANCE SYSTEMS